

BT exact  
TECHNOLOGIES

france telecom



Consulintel  
Consultores Integrales en Telecomunicaciones

Euro6IX  
IPv6: The New Internet

ECIJA & ASOCIADOS  
ABOGADOS  
Derecho Administrativo, Propiedad Intelectual  
y Nuevas Tecnologías

ERICSSON



# The Pan-European IPv6 IX Backbone Towards deployment of IPv6 in Telcos / ISPs

dit  
UPM

Telefonica  
TELEFÓNICA  
INVESTIGACIÓN Y DESARROLLO

University  
of Southampton

TELECOM LAB  
ITALIA  
www.telecomitaliab.com

Jordi Palet (jordi.palet@consulintel.es)

CEO/CTO - Consulintel

6NET Workshop

21/05/2003

vodafone

P T Inovação



TELSCOM

WIND

Euro6IX  
IPv6: The New Internet

Information Society  
Technologies

# Euro6IX Goal

- Support the fast introduction of IPv6 in Europe.
- Main Steps:
  - Network design & deployment
  - Research on network advanced services
  - Development of applications validated by user groups & international trials
  - Active dissemination:
    - participation in events/conferences/papers
    - contributions to standards
    - project web site

# Consortium Members (17)

- Telcos/ISPs (7):
  - Telecom Italia LAB (WP2 leader), Telefónica I+D (WP3 leader and project coordinator), Airtel-Vodafone, British Telecom Exact, T-Nova (Deutsche Telecom), France Telecom RD, Portugal Telecom Inovação
- Industrial (2):
  - 6Wind, Ericsson Telebit
- Universities (3):
  - Technical University of Madrid (WP4 leader), University of Southampton, University of Murcia
- Research, System Integrators and Consultancy (3):
  - Consulintel (WP1 leader and project coordinator), Telscom (WP5 leader), novaGnet systems
- Others (2):
  - Écija & Asociados Abogados, Eurocontrol



# Updated Network Map

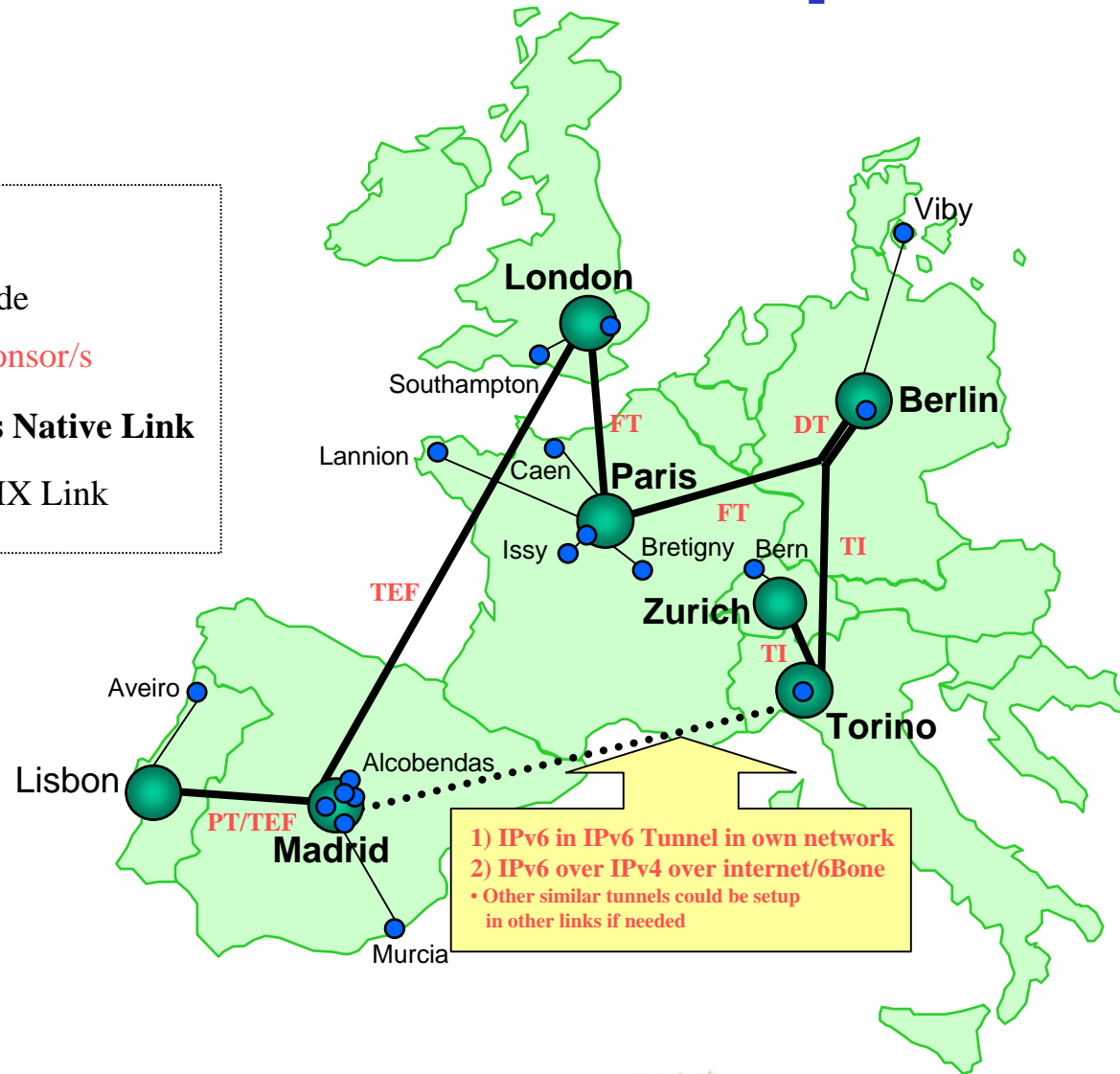
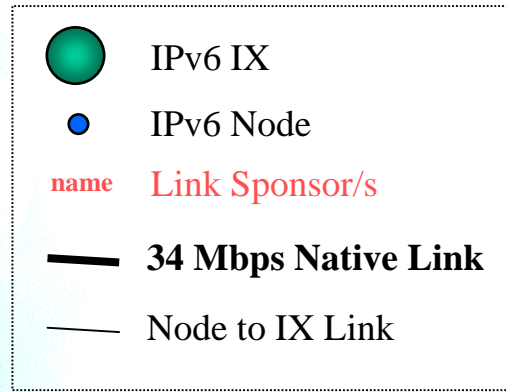

1) IPv6 in IPv6 Tunnel in own network  
 2) IPv6 over IPv4 over internet/6Bone  
 • Other similar tunnels could be setup in other links if needed

# IX Model C

- L2 infrastructure (fully redundant) where the IX services are placed
- Routers infrastructure (long-haul providers and customers)
- Layer 3 mediation function router (L3MF) is the real new element of this model

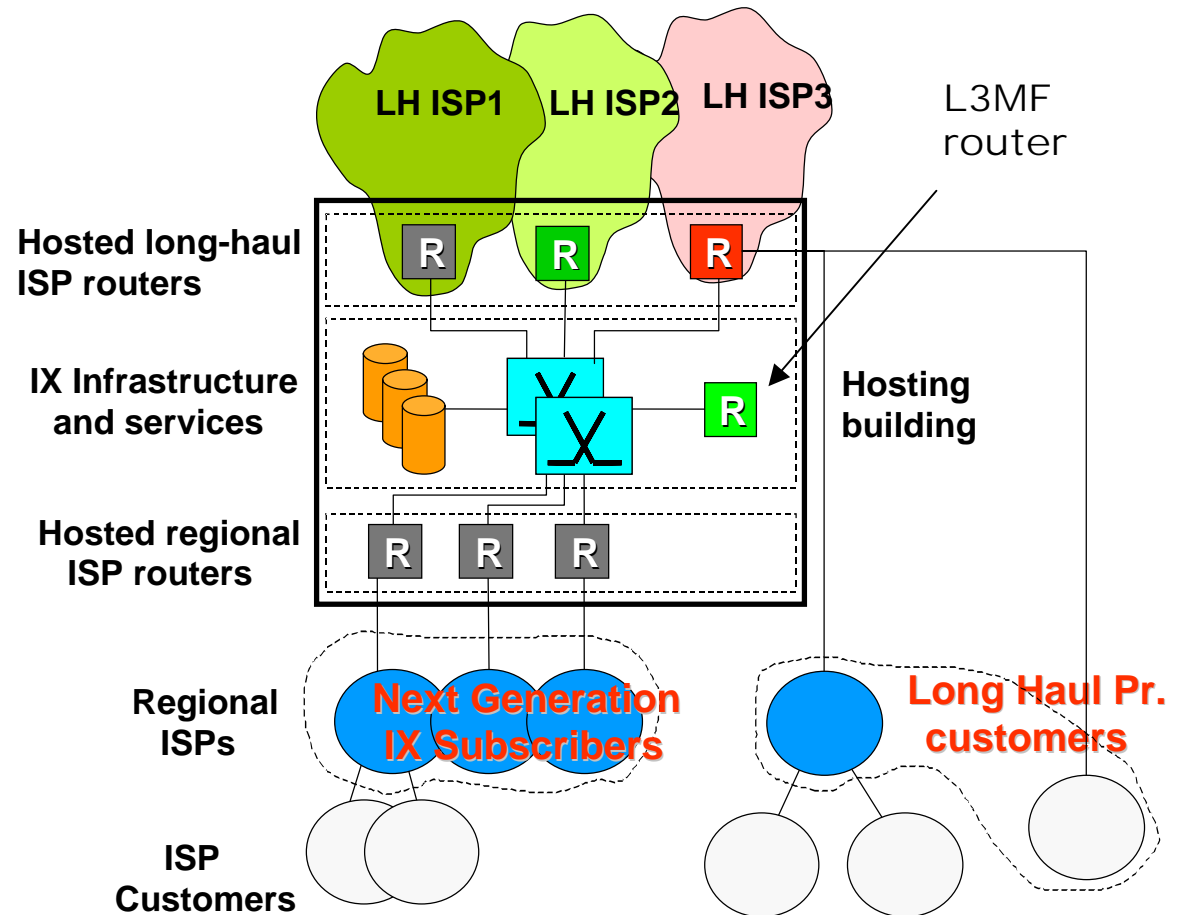

# RFC2374 Benefits

- This model is based on the RFC 2374 to verify that:
  - a customer could change its service provider without changing its addressing space
  - the renumbering functionality could be realized more easily (no renumbering in the better case)
  - the multihoming functionality could be realized more easily
- IX plays an intermediation role between the ISP and the customers (Layer 3 mediation function router)
- Routing:
  - iBGP+IGP: inside the Long Haul Provider
  - Euro6IX is the collection of the routers inside the IX emulating the LHP (single AS)
  - eBGP4+: between the customers and the IX
  - eBGP4+: between the IX and the LHPs

# IX Based Services

- IX becomes a place where new services are offered to the users.
- IX is an aggregation point, so it can provide those services who can benefit by this “user aggregation” (e.g. in a based multicast network, the RP could be located inside the IX, because a lot of users connect to it).
  - Network Services
    - Multicast, AAA, QoS, DNSSec
    - Transition Mechanisms: NAT-PT, Tunnel Broker, 6to4
    - Route Server mechanism
  - Application Services
    - HTTP, FTP, SMTP
    - VideoConference/e-learning services
    - P2P applications
  - Monitoring Services
    - Routing/Traffic/Reachability Monitoring (Magalia, AS-Path tree, Looking Glass)



# The UK6x (LON6IX)



- Layer 2 & 3 IPv6 Internet exchange
- First in the UK
- Uses commercial IPv6 addresses
- Located at the heart of the UK Internet – Telehouse
- Open to all
- Primary aims are:
  - to stimulate the IPv6 environment in the UK, Europe and the World
  - to further the understanding of IPv6





# UK6x Core Architecture



- Ethernet switch for Layer 2 peering
- ATM switch for additional customer access mechanisms
- Router for Layer 3 functionality
- 2001:618::/32 used for address allocation
- 2001:7F8:2::/48 used for infrastructure
- Maintenance via Looking Glass, ASpath-tree etc.

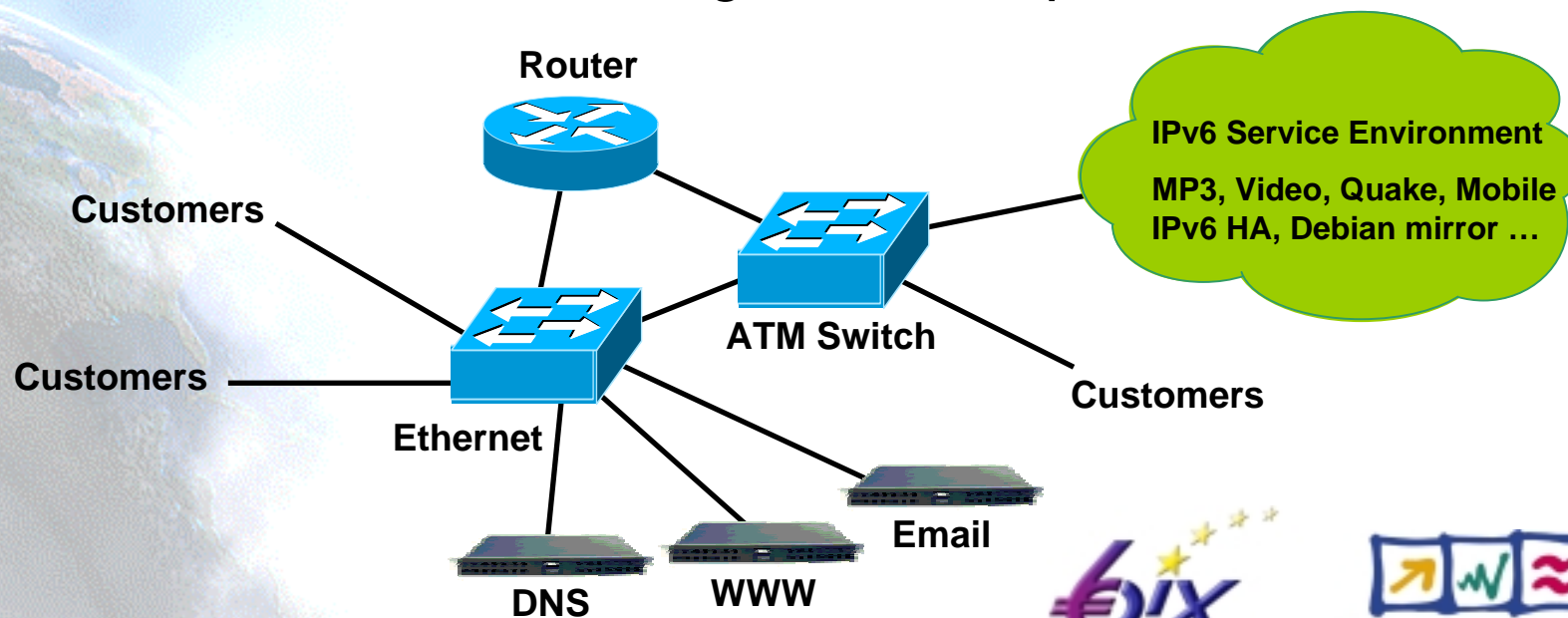

# UK6x Connectivity

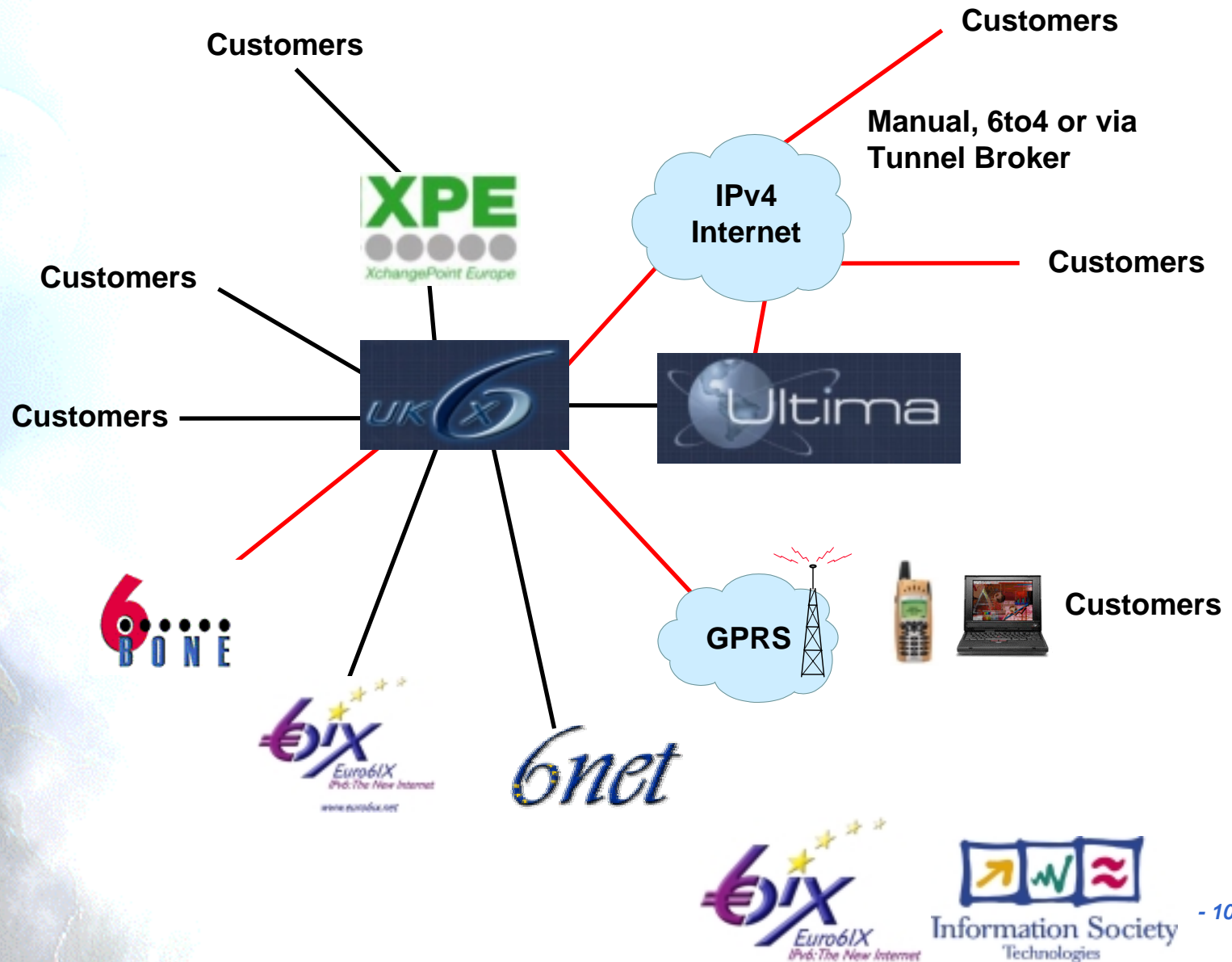

# DNSsec Services

- UPM is completing the DNS emulation environment
- Developing a complete set of DNSSEC example configurations using the emulation environment
- DNSSEC pilot work on setting-up and maintaining experiment between UMU, Consulintel and UPM
- Publishing certificates using DNSsec
  - Models analyzed to publish certificates:
    - TSIG Model: symmetric keys.
    - SIG Model: asymmetric keys.
  - Support in PKIv6:
    - PKIv6 supports TSIG Model
      - BIND 9.2.0 or newer for TSIG
    - PKIv6 will support SIG Model
      - BIND 9.3.0 (snapshot) for SIG(0)

# IX service PKIv6 to publish certificates using DNSSEC

- Scenario 1:
  - Root CA and Name Server are together in the IX

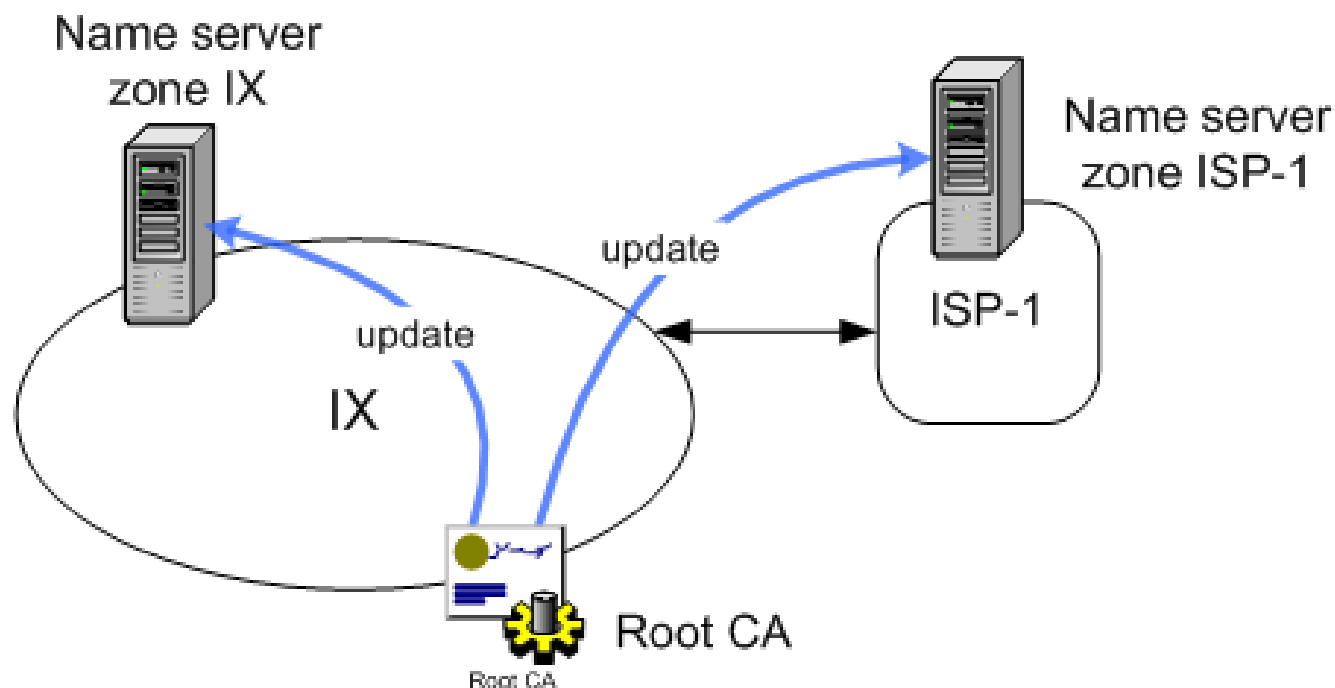

# IX service PKIv6 to publish certificates using DNSSEC

- Scenario 2:
  - Root CA is out

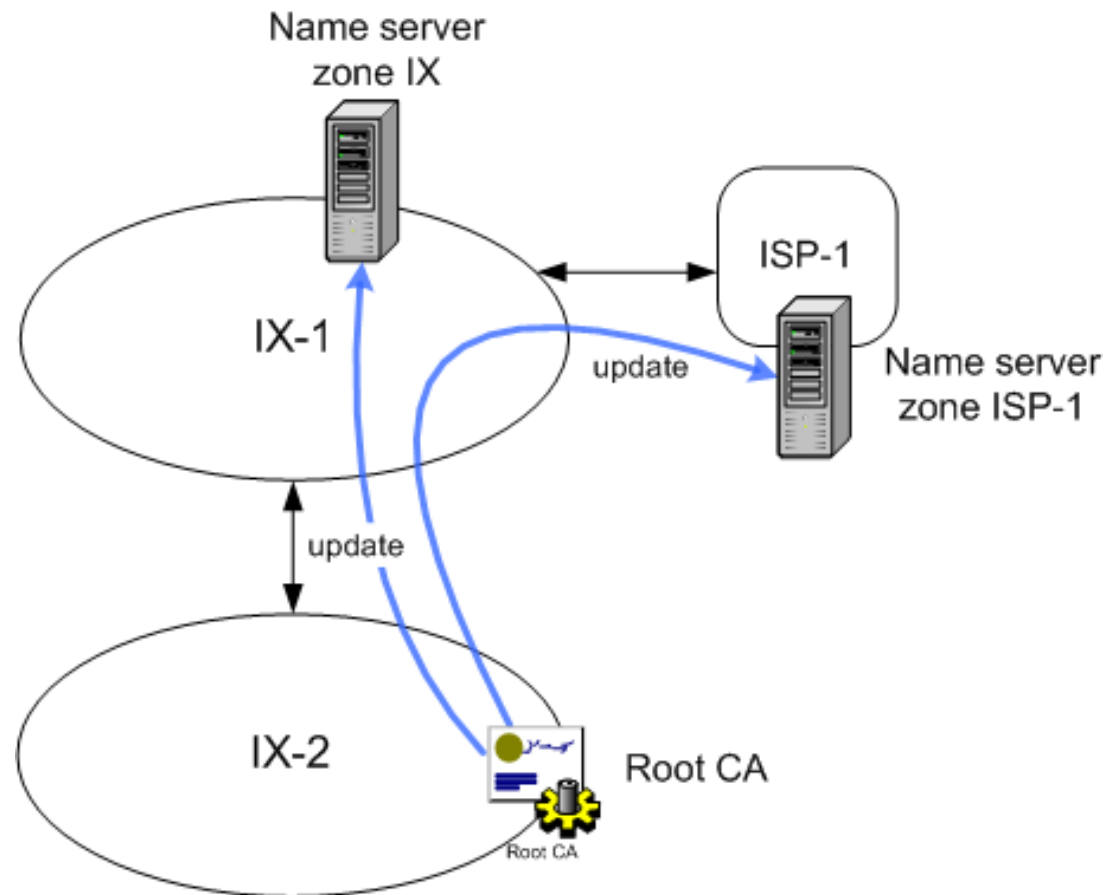

# Security Framework

- General VPN Policy Definition. Tools VPNEtool
- Tested with UCL in 6NET-Euro6IX collaboration
- 6WIND VPN Enforcement element working, and being tested by 6WIND
- CISCO: Waiting CISCO IOS version that could be accessible with support for IPsec for IPv6. Actually working with IPv4

# Instant Messaging v1

- Jabber based
- Developed using Java
- Up to now, we have
  - Deployed and debug the Jabber IM server
  - Developed the GUI based IM client
  - Debugged the interaction of IM client and IM server
  - Migrated to IPv6 Internet
- IM Services include:
  - User management:
    - register/unregister; login/out;
  - Roster management:
    - add/delete friends
  - Messaging
  - Presence management
  - Group management:
    - join/leave group
  - Group chat

# Instant Messaging v2

- Client relayed multicast messaging
  - based on the Jabber address scheme
  - some clients can be configured to relay the chat messages
  - balance the store-forward load on the IM server
  - easily integrated to IM version 1
  - prototype implemented



# VOCAL

- Porting was undertaken within the Euro6IX project ([www.euro6ix.org](http://www.euro6ix.org))
  - But also in conjunction with 6NET ([www.6net.org](http://www.6net.org))
  - Work done by a researcher between degree and PhD
  - Being used in 6NET, 6WINIT and Euro6IX
  - Quality of VoIP depends largely on latencies in hardware
- Now moving to VOCAL+ENUM integration
  - A lot of issues to be sorted out

# Thanks !

## Contact:

- **Jordi Palet (Consulintel): [jordi.palet@consulintel.es](mailto:jordi.palet@consulintel.es)**
- **Madrid 2004 Global IPv6 Summit (1<sup>st</sup> Week Nov. 2004):**  
**<http://www.ipv6-es.com>**
- **Euro6IX Project Coordinators**  
**([coordinators@euro6ix.org](mailto:coordinators@euro6ix.org)):**
  - **Jordi Palet Martínez (Consulintel):** [jordi.palet@consulintel.es](mailto:jordi.palet@consulintel.es)
  - **Carlos Ralli Ucendo (Telefónica I+D):** [ralli@tid.es](mailto:ralli@tid.es)

